

**Battery Powered  
D-Handle Impact Wrench  
910210  
Operating Instructions**



# D-Handle Impact Wrench

## 910210

### Record of Changes

Rev No.	Date	Description of Changes
Rev. 1	6.2023	Initial release

## Table of Contents

Section 1: Overview and Safety .....	5
Battery Powered D-Handle Impact Wrench Overview .....	5
Environmental Protection .....	5
Safety Information .....	5
Safety Terms .....	6
Machine Use and Safety Precautions .....	6
Section 2: Specifications & Charging the Battery .....	7
Specifications.....	7
Packing Contents .....	7
Battery and Charger.....	8
Charging Process .....	9
Section 3: Tool Operation .....	10
Personal Protective Equipment.....	10
Lithium-Ion Battery Installation.....	10
Lithium-Ion Battery Check .....	11
Powering On the Wrench .....	12
Wrench Operation.....	13
After Use.....	13
Section 4: Maintenance.....	14
Troubleshooting .....	14
Storage .....	14
Lithium Battery Maintenance.....	15
Section 5: Parts and Service Support.....	16
Service Parts .....	17
Section 6: Warranty Terms and Conditions .....	18

**This page was intentionally left blank.**

## Section 1: Overview and Safety

### Battery Powered D-Handle Impact Wrench Overview

RRP designs and manufactures equipment primarily for the repair and new construction of rail and railroad tie track maintenance.

The D-Handle Impact Wrench is a portable, battery powered, impact wrench and its designed allows the operator greater flexibility in tighter work areas. Ergonomic handles give handhold positioning for either horizontal track bolts or working vertically for lag screws.

**Do not** use this machine for other than its intended purpose.

Please read these instructions when using this tool, which can only be used for the specified purpose. This instruction manual should be kept throughout the life of the tool.

The operator of this tool should:

- Have access to this operation instruction.
- Read and understand this operation instruction.

### Environmental Protection



Comply with relevant national waste disposal laws and regulations. Waste electronic devices cannot be treated as household waste.

Equipment, accessories, and packaging shall be recyclable.



Don't throw the discarded equipment in trash cans.

### Safety Information

For safe installation and operation of this equipment, carefully read and understand the contents of this manual. Improper operation, handling, or maintenance can result in equipment damage and personal injury.

Only trained and authorized personnel should be allowed to operate this machine. In addition, all personnel at the worksite should be aware of the safety concerns and their individual responsibilities prior to working this machine.

Please read and comply with all the safety precautions in this manual **before** operating this machine. Your safety is at risk.

This operation manual contains important safety and operating instructions for batteries and chargers. Before using the charger, please read all instructions and warnings on the charger, battery, and the tool.

## Safety Terms



**DANGER** indicates a hazardous operating procedure, practice, or condition. If the hazardous situation is not avoided death or serious injury will occur.



**WARNING** indicates a hazardous operating procedure, practice, or condition. If the hazardous situation is not avoided death or serious injury could occur.



**CAUTION** indicates a potentially hazardous operating procedure, practice, or condition. If the hazardous situation is not moderate or minor injury could occur.

## Machine Use and Safety Precautions



Failure to follow safety precautions when operating this equipment can result in serious injury or death to the operator or other persons in the area.  
**Observe the following precautions whenever you are operating, working on or near this equipment.**

**Do not** make any modifications without authorization or written approval from Racine Railroad Products. Replace all Racine Railroad Products and OEM parts with genuine Racine Railroad Products and OEM parts. Using non-OEM parts may compromise the safety of the machine.

**Do not** wear loose clothing, jewelry, radio belts, etc., when operating, working on or near this equipment. They can be caught in moving parts and may result in severe injury.

**Always** wear appropriate personal protective clothing when operating this equipment: e.g., orange safety vest, hard hat, safety glasses with side shields, hearing protection, steel-toed safety boots, leather gloves, dust respirator, etc.

**Always** lift heavy objects with the knees and legs, not the arms and back.

**Always** keep hands, arms, feet, head, clothing, etc., out of the operating area and away from all rotating or moving components when operating, working on or near this machine.

**Always** make sure that all guards, covers, belts, hoses, and operating components are in good working order and that all controls are in the appropriate position before starting the engine.

**Always** make sure that all safety equipment installed properly and are in good working order. Do not operate the machine until unsafe conditions have been corrected.

**Always** operate in a well-ventilated area and make sure that the air filters, air filter covers, and muffler are in good condition.

**Always** keep the machine clean and free of debris. Operate the machine in a safe and responsible manner. Exercise caution when fueling, working on or near rotating or moving components, hot components, and fuel systems. Be aware of potential fire hazards and prevent sparks, exhaust, etc., from starting fires on the machine and/or work area.

**Always** comply with all instructions provided on any decals or placards installed on the machine and with any relevant amplifying information provided in this manual or other general operating procedures.

**Always** shut disconnect the power source and make sure that all controls are in a safe position and install all appropriate locking and safety devices before doing any of the following:

- Lubricating
- Adjusting
- Installing Tooling
- Making Repairs
- Performing Service

## Section 2: Specifications & Charging the Battery

### Specifications

Rated power.....	3 KW
Frequency.....	0-2200/min
Maximum Tightening Torque.....	3000 Nm
Maximum Loosening Torque .....	3500Nm
Battery Life (one charge)	
Tightening about 200 S46 bolts	
Loosening about 250 S46 bolts	
Waterproof Grade .....	IP45 (Suitable for heavy rain)
Weight (excluding socket and battery).....	19.8 lbs (9 kg)

### Battery Parameters

Battery type.....	Lithium-Ion battery
Battery output voltage .....	36 DC
Battery current.....	12 Ah
Recharger voltage.....	120 VAC
Work Temperature .....	-40 °F – 113 °F (-40 °C– 45 °C)
Weight.....	12.7 lbs (5.8 kg)

### Packing Contents



- D-Handle Impact Wrench
- Battery
- Auxiliary Handle (not shown)
- Battery Charger (not shown)
- 4 mm allen wrench (not shown)
- (4) M5 x 16 screws (not shown)

## Battery and Charger

If the battery is cracked or damaged, do not insert it into the charger. This can cause electric shock.

Do not allow liquid to enter the charger as this may cause an electric shock accident. Do not place chargers or batteries in hot, unventilated environments such as metal sheds or trailers.

The charger can only charge rechargeable batteries. Using it for other purposes can lead to accidents such as fires.

Do not place any object on top of the charger. Do not place the charger on a soft surface that may cause excessive internal heat. Do not place the charger near any heat source.

To reduce the potential risk of damage to the power plug and power cord, unplug the power supply when the charger is disconnected from the power supply.

Make sure the power cord is in place so that it will not be stepped on, loosened, or otherwise damaged or under pressure

Extension cords must not be used unless necessary. The use of extension cords may cause a fire and a risk of electric shock.

If the charger has been hit hard, dropped or otherwise damaged, the charger must not be used.

Do not disassemble the charger. If maintenance or repairs are required, take them to a service agent. Improper reassembly can raise the risk of electric shock or fire.

To prevent the risk of electric shock, unplug the charger from the electrical outlet before wiping the charger. Removing the battery from the charger is not enough to reduce the risk of electric shock.

The tool, charger, and battery may not be stored in or used in places where temperatures may reach or exceed 104 °F / 40 °C. This will lead to the deterioration of the battery.

This charger can only be used on standard household power supplies (100~240Vac). Do not attempt to use the charger on any other power supply.

### Battery Additional Information

When removed from the package, the battery is not fully charged. First, read the instructions and follow the charger instructions and steps.

- *Refer to the battery and charger instruction manual in the battery package.*

If the battery is charged in temperatures between 64 °F / 18 °C and 77 °F / 25 °C, the battery has the longest service life and the best performance. Charge the battery at temperatures below -22 °F / -30 °C or above 113 °F / 45 °C, and the battery will be automatically disconnected from charging.

Even if the battery is severely damaged or completely damaged, the battery must not be incinerated. The battery will explode in a fire.

Never try to open the battery for any reason. If the plastic casing of the battery is broken, stop using it immediately and do not charge it.

The service life of the battery depends on the type of application. This battery has the longest trouble-free service life. However, like all batteries, it will eventually break down.



To get the longest possible battery life, we offer the following recommendations.

- Store the battery in cool areas and charge them in such areas. Temperatures above or below normal room temperature can shorten the life of the battery.
- Never store the battery under discharge. The battery needs to be recharged immediately after discharging
- All batteries gradually lose charge. The higher the temperature, the faster the battery loses charge.
- If the tool is stored for a long time without use, the battery must be charged every other month or two months. Doing so can extend the life of the battery.

## Charging Process

The battery of the new machine is not fully charged.

1. Connect the power cord to the charger and then plug the charger into a suitable power outlet before connecting the battery.
2. Insert the battery into the charger. Make sure the battery is securely installed in the charger.
  - When the light of the charger is *red*, it indicates that the battery is charging.
  - When the light of the charger is *green*, it indicates that charging the battery is complete.

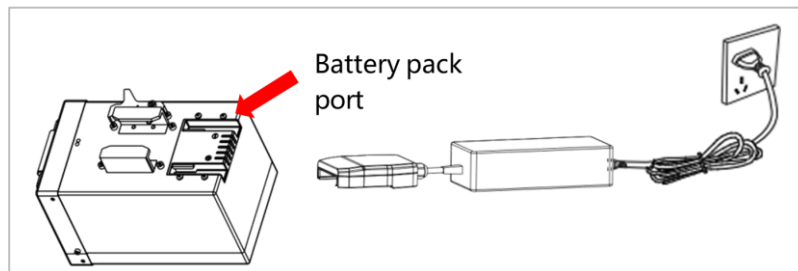

### Section 3: Tool Operation

#### Personal Protective Equipment



Before operating this machine, make sure that all general safety precautions are observed, and that proper personal protective clothing is worn as described below.

At a minimum, operators should wear the following Personal Protective Equipment:

1. Safety Glasses
2. Hearing Protection
3. Hard Hat
4. High Visibility Safety Vest
5. Leather Work Gloves

#### Lithium-Ion Battery Installation

1. Insert the battery into the position shown in the figure.
2. Lock the battery with the battery lock.
  - Press the battery button to open the battery.
  - The battery will automatically turn off after 3-5 minutes without any operation.

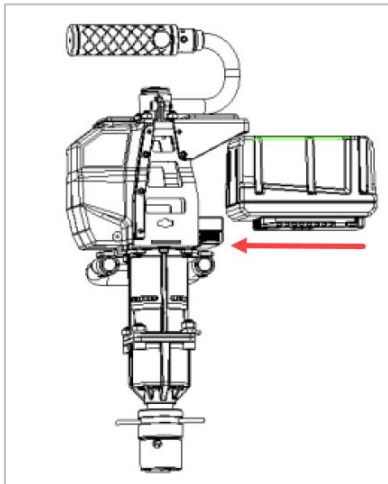

3. Press the Safety Switch before turning ON the wrench.
  - To restart the wrench, press the Safety Switch.
  - Note: The Safety Switch will automatically lock after two minutes of no operation.



### Lithium-Ion Battery Check

1. Check the battery power level before use.
2. **On the battery** press the power switch.  
The LED lights will light up and indicate battery power level and alarm information.
3. Press and hold the power switch to power off the battery.

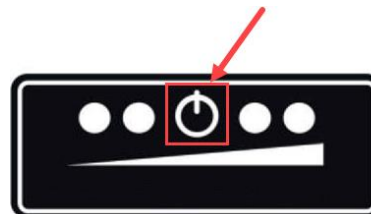

Battery Power Switch



Battery level 75%~100% .....4 LEDs light up



Battery Level 50%~75% .....3 LEDs light up



Battery level 25%~50% .....2 LEDs light up



Battery level 10%~25% .....1 LED blinks.



If LED 1 and LED 4 blink .....It indicates high temperature alarm.

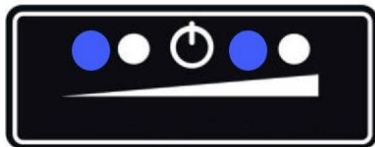

If LED 1 and LED 3 blink .....It indicates low temperature alarm.

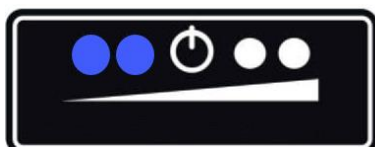



LED1 and LED2 blink .....It indicates an overcurrent alarm.

### Powering On the Wrench

1. Press the battery power switch to ON.

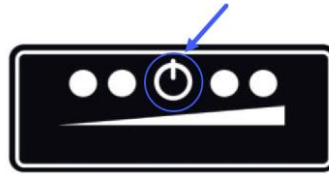
The Boot LED will light up red, indicating the default gear (6<sup>th</sup>).





2. Press the Change-Over switch to adjust the direction
3. Press the   buttons on the control panel to adjust the desired torque.
4. Press the Safety Switch.
  - The Boot LED will light up green.
5. Press the Start button. Check the following:
  - forward and reverse action are functioning correctly.  
F indicates tightening. R indicates loosening.
  - if there is abnormal noise.
  - if all actions are working correctly.

**Note:** The forward and reverse action cannot be adjusted without turning on the safety switch.

### Wrench Operation

#### 1. Adjust the Wrench Torque

The  and  buttons are used to adjust the torque power.

- Press the  to increase the torque power.
- Press the  button to decrease the torque power.
- The default setting is 6.



2. Place the socket over the bolt.
3. Start the wrench.
4. Press and hold the button when fastening (or loosening) the bolt.
5. The operation will stop automatically when the torque reaches the set value.

### After Use

1. Turn the power OFF as soon as possible after operation.  
The battery function automatically turns OFF after 3 minutes of no operation.
2. To restart, press the safety switch.

## Section 4: Maintenance

It is highly recommended to practice regular check-ups and maintenance in accordance with the usage frequency to keep your tool in better condition and reduces total running costs.

1. After the job is done, clean the machine and keep in a clean place.  
Anti-rust oil can be applied to the surface. Recommended oil is WD-40.
2. Use a new socket when the old socket is worn out or damaged.
3. Turn OFF the battery and removed it from the machine when doing maintenance or repair.

## Troubleshooting

Problem	Possible Cause	Resolution
The motor does not start properly	The battery is out of charge	Recharge the battery
	The safety switch is not turned on	Turn on the safety switch
Bolts cannot be tightened and loosen	Socket wear	Change the socket

## Storage

1. If not being used for an extended period of time, remove the socket from the machine and stored it separately.
2. Apply anti-rust oil on the surface of the machine and keep it in a ventilated, dry, corrosive, gas-free environment.  
machine and keep it in a ventilated, dry, corrosive, gas-free environment.
3. After the job is completed, remove the battery from the machine and store separately.
4. Charge the battery with 50% ~ 80% of the power and stored in a dry and cool environment (refrigeration conditions are more effective).

Charged the battery every 2 months to help to avoid irreversible battery capacity loss due to self-discharge and long term storage.

avoid irreversible battery capacity loss due to self-discharge and long term storage.

## Lithium Battery Maintenance

1. Fully charge a new battery before using it the first time. Please check the battery status each time before using it. If there is anything abnormal, please return it to the distributor for inspection and maintenance.
2. Lithium batteries should be charged with the corresponding special charger, do not use other different types of chargers that have not been approved by the manufacturer.
3. When the battery has just been used for a long time, it should not be charged immediately, it should be left for about 1 hour, waiting for the battery temperature to drop to the ambient temperature before charging.
4. During use, it is noted that lithium batteries should not be over-discharged, and excessive discharge will cause irreversible capacity loss. Please stop working when the battery is low (the red light is flashing), and don't run out of power.
5. Store the battery in cool, dry, and safe areas. Do not store the battery in an environment where the temperatures is above 104 °F / 40 °C. It will inevitably cause corresponding damage to the quality of the battery, and even cause danger.
6. Do not mix the lithium battery with metal items, avoid touching the positive and negative poles of the battery. This could result in a short circuit, damage to the battery, and even cause danger.
7. Avoid bringing lithium batteries near heat sources, open flames, flammable and explosive gases, liquid. This can lead to battery leakage, heat, smoke, fire, and bursting.
8. The battery should be charged with 50% ~ 80% of the power and stored in a dry and cool environment if it is not in use for long term (refrigeration conditions are more effective). It should be charged every 2 months and be checked every month.
9. Please try to avoid using lithium batteries in environments where the ambient temperature is above 113 °F / 45 °C or below -40 °F / -40 °C, battery life will be affected. The ambient temperature when charging should not exceed 113 °F / 45 °C or -40 °F / -40 °C.
10. To maintain the good working condition of the lithium battery, it should be returned to the distributor every 12 months for maintenance. When lithium batteries are used on devices with high vibration, for example wrenches, tamping tool and profile grinder, it is necessary to return to the distributor for maintenance every 6 months.

## Section 5: Parts and Service Support

### Technical Support & Service

Telephone and web-based technical support is available for current production models through our Customer Service Department. Service Manuals and limited technical support may be available for models that are no longer in production.

through our Customer Service Department. Service Manuals and limited technical support may be available for models that are no longer in production.

### Telephone and E-mail Technical Support

Telephone and e-mail technical support is available on normal U.S. business days from 8:00 AM to 5:00 PM U.S. Central Time Zone (GMT +6 (+5 Daylight Savings Time)).



1955 Norwood Court

Mount Pleasant, WI 53403

Phone: (262) 637-9681

Email: [custserv@racinerailroad.com](mailto:custserv@racinerailroad.com)

[racinerailroad.com](http://racinerailroad.com)



Unit 3 Hartington Industrial Estate

Chesterfield • Derbyshire, S43 3YF

Phone: 0330 164 1375

Email: [info@racinerailroad.co.uk](mailto:info@racinerailroad.co.uk)

[racinerailroad.co.uk](http://racinerailroad.co.uk)

### Non-Warranty Technical Support

Depending upon the circumstances and availability of technical service personnel, we may provide technical assistance and/or field service support, *at the customer's expense*, to assist in the correction of non-warranty related problems. Contact our Customer Service Department to coordinate Non-Warranty Technical or Field Service Support.

### Warranty Support Technical Support

Depending upon the circumstances and availability of technical service personnel, we may provide technical assistance and/or field service support, *at no charge to the customer*, to assist in the correction of warranty related problems. Contact our Customer Service Department to coordinate Warranty Technical or Field Service Support.

### Warranty Parts Claims

Material claimed to be defective must be returned to our factory for evaluation. Defective materials will be replaced, or your account will be credited if replacement materials have already been purchased. Please contact our Customer Service Department at the address provided below if you have any questions or problems.

### Warranty Service Support

Depending upon the circumstances and availability of technical service personnel, we may provide technical assistance and/or field service support, at no charge to the customer, to assist in the correction of warranty related problems. Contact our Customer Service Department at the address provided above to coordinate Warranty Service Support.



Service Parts

NO.	QTY	DESCRIPTION	PART NO.
1	REF	1" - S36 SOCKET ASSEMBLY	476897
2	REF	CASE, IMPACT	476898
3	REF	1" T STYLE POWER SHAFT ASSY	476899
4	REF	UNIT, IMPACT TRANSMISSION	476900
5	REF	BEARING 6004	476901
6	REF	BELT BRACKET	476902
7	REF	CASE, MOTOR	476903
8	REF	MOTOR ASSEMBLY	476904
9	REF	SEAT, MOTOR	476905
10	REF	CONNECTOR, BATTERY	476906
11	REF	CASE, MAIN RIGHT	476907
12	REF	ELECTRICAL CONTROL ASSEMBLY	476908
15	REF	UNIT, DISPLAY	476909
18	REF	SWITCH, REVERSE	476911
20	REF	SWITCH, METAL ON/OFF	476912
21	REF	PACK, 36V BATTERY	476894
22	REF	RECHARGER, 36V	476895
23	REF	CASE, MAIN LEFT	476915

## Section 6: Warranty Terms and Conditions

### Warranty Period

Each new machine and new parts of our manufacture are warranted against defects in material and workmanship for one year from the date of shipment from our factory.

When contacting customer service for factory parts, service or warranty support please provide the:

- Racine Railroad Products Model
- Serial Number
- Any locally assigned identification

### Vendor Parts Warranty Period

Other equipment and parts used, but not manufactured by Racine Railroad Products, Inc., are covered directly by the manufacturer's warranty for their products.

### Warranty Parts and Service

We will repair or replace, without charge, F.O.B. factory, Racine, Wisconsin, USA, any part Racine Railroad Products manufactures which is proven to be defective during the warranty period.

Material claimed defective must be returned, if requested, to the factory within 30 days from the date of the claim for replacement. Ordinary wear and tear, abuse, misuse, and neglect are not covered by this warranty. Depending upon the circumstances, we may provide technical assistance and/or technical service support, without charge, to assist in the correction of warranty related problems.

### Non-Warranty Parts and Service

Material damaged through normal wear and tear, abuse, misuse and/or neglect are not covered by our warranty and should be ordered directly from our Customer Service.

**Note:** Parts for models that are no longer in production may not be available.

### Non-Warranty Parts Orders

When placing a parts order please provide the following information:

- Company Name and Billing Address
- Purchase Order Number and Issuing Authority
- Shipping Address
- Special Handling Instructions
- Contact Phone Number
- Machine Model and Serial Number
- Part Numbers and Quantities Being Ordered

**Note:** *Please use Racine Railroad Products part numbers when ordering parts.* Racine Railroad Products part numbers are shown in the parts lists and drawings of this manual and have only six (6) numbers.

Any part number with other than six numbers (e.g., contains alpha-numeric characters) is a Vendor Part Number and **not** a Racine Railroad Products part number.